

MICROREGOLATORI 1/8" - 1/4"

1/8" - 1/4" Microregulators



Serie **038 - 039**

MICROREGOLATORI - Serie 038

MICROREGULATORS - 038 line

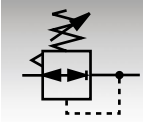

Microregolatore 1/8"-1/4"

1/8"-1/4" Microregulator

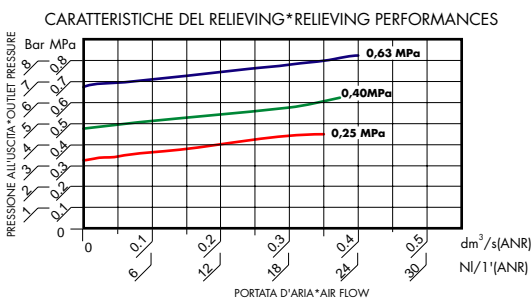
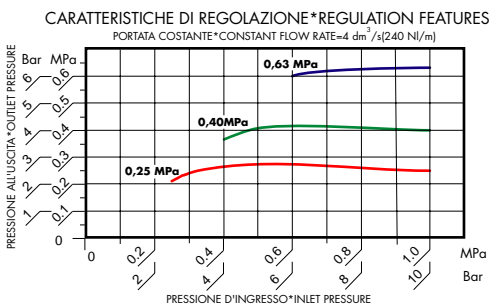
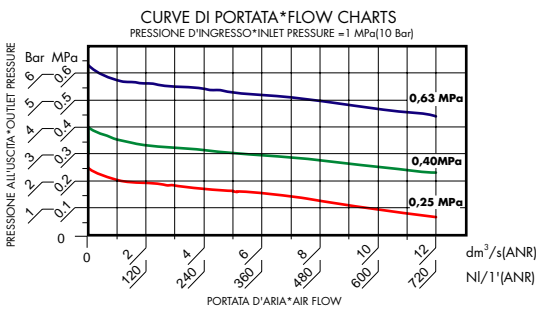
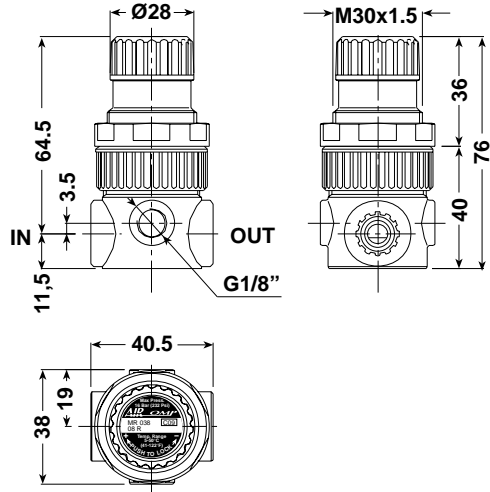

Microregolatore

Adatto per innumerevoli applicazioni industriali.

- * Funzionamento a membrana.
- * Completo di ghiera per il montaggio a pannello.
- * Possibilità di fissaggio a parete su staffa.
- * Pomello con dispositivo di bloccaggio della regolazione.
- * Utilizzabile nelle versioni per aria (con relieving e pomello rosso) e per acqua (senza relieving e pomello nero).
- * Campi di pressione:
 0÷2 Bar, 0÷4 Bar, 0÷8 Bar (standard), 0÷12,5 Bar
 0÷0,2 MPa, 0÷0,4 MPa, 0÷0,8 MPa (standard), 0÷1,25 MPa
- * Pressione massima d'ingresso: 16 Bar (1,60 MPa).
- * Range di temperatura: 5÷50°C (41÷122°F).
- * Coppia di serraggio max. inserti G1/8" IN-OUT: 20 N·m.
- * Coppia di serraggio max. inserti G1/4" IN-OUT: 25 N·m.
- * Portata di riferimento (P=6,3 Bar - Δp=1 Bar): 360 NI/min.
- * Peso: 0,095 Kg.

Microregulator

Suitable for many industrial uses.

- * Diaphragm operation.
- * Complete with ring nut for panel assembly.
- * Can be wall mounted on a bracket.
- * Lockable safety knob.
- * Can be used in air (with relieving and red knob) and water (without relieving and with black knob).
- * Pressure ranges:
 0÷2 Bar, 0÷4 Bar, 0÷8 Bar (standard), 0÷12,5 Bar
 0÷0,2 MPa, 0÷0,4 MPa, 0÷0,8 MPa (standard), 0÷1,25 MPa
- * Maximum inlet pressure: 16 Bar (1,60 MPa).
- * Temperature range: 5÷50°C (41÷122°F).
- * Max. torque inserts G1/8" IN-OUT: 20 N·m.
- * Max. torque inserts G1/4" IN-OUT: 25 N·m.
- * Reference flow rate (P=6,3 Bar - Δp=1 Bar): 360 NI/min.
- * Weight: 0,095 Kg.

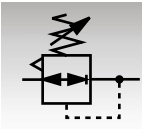

Microregolatore 1/8" LC

1/8" Microregulator LC

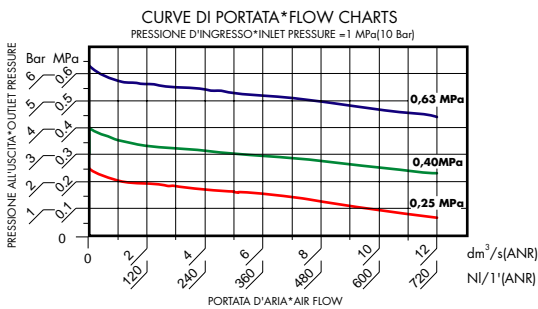
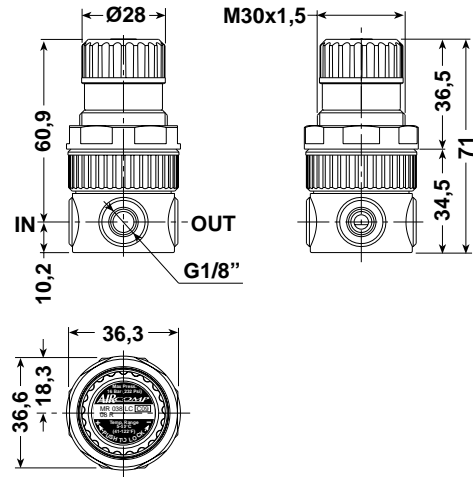

Microregolatore LC

- Modello speciale, particolarmente resistente alle aggressioni chimiche.
- * Corpo interamente in "POM" a 2 o 4 vie da G1/8".
 - * Connessioni direttamente ricavate sul corpo (senza inserti).
 - * Componenti a contatto con il fluido: EPDM + INOX + PUR + POM.
 - * Montaggio e collaudo eseguiti in assenza di olii e grassi.
 - * Campi di pressione:
 0÷2 Bar, 0÷4 Bar, 0÷8 Bar (standard), 0÷12,5 Bar
 0÷0,2 MPa, 0÷0,4 MPa, 0÷0,8 MPa (standard), 0÷1,25 MPa
 - * Portata di riferimento (P=6,3 Bar - Δp=1 Bar): 360 NI/min.
 - * Peso: 0,078 Kg.

Caratteristiche tecniche

Technical Features

COMPONENTI

- 1- Perno membrana in "INOX"
- 2- Corpo valvola in "PUR"
- 3- Corpo regolatore in "POM"
- 4- Membrana in "EPDM"
- 5- Ugello in "POM"
- 6- Stelo valvola in "INOX"
- 7- Molla ritorno valvola in "INOX"

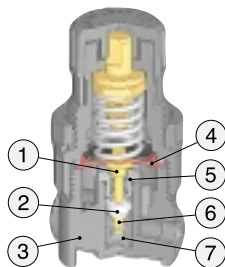

COMPONENTS

- 1- Diaphragm pin: INOX
- 2- Body valve: PUR
- 3- Regulator body: POM
- 4- Diaphragm: EPDM
- 5- Nozzle: POM
- 6- Valve rod: INOX
- 7- Spring return valve: INOX

Microregulator LC

- Special type, particularly resistant to chemical agents.
- * Body completely made in "POM" with 2 or 3 ways G1/8".
 - * Connections obtained directly on the body (without inserts).
 - * Components in touch with fluid made in: EPDM, INOX, PUR, POM.
 - * Assembly and test made without oil and grease.
 - * Pressure ranges:
 0÷2 Bar, 0÷4 Bar, 0÷8 Bar (standard), 0÷12,5 Bar
 0÷0,2 MPa, 0÷0,4 MPa, 0÷0,8 MPa (standard), 0÷1,25 MPa
 - * Reference flow rate (P=6,3 Bar - Δp=1 Bar): 360 NI/min.
 - * Weight: 0,078 Kg.

CORPO A 4 VIE
(con 2 uscite manometro)



4 WAY BODY
(With 2 gauge ports)

CORPO A 2 VIE
(senza uscite manometro)

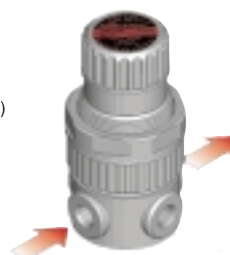

2 WAY BODY
(Without gauge ports)

MICROREGOLATORI - Serie 039

MICROREGULATORS - 039 line



Microregolatore di precisione

Precision microregulator

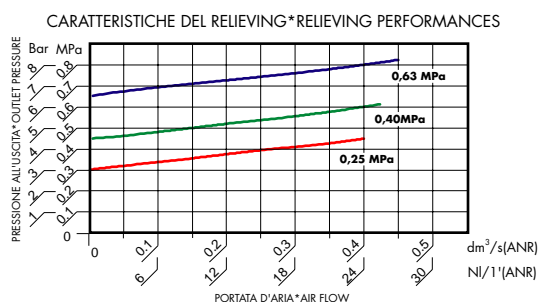
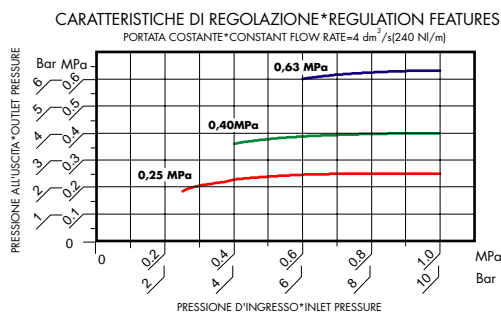
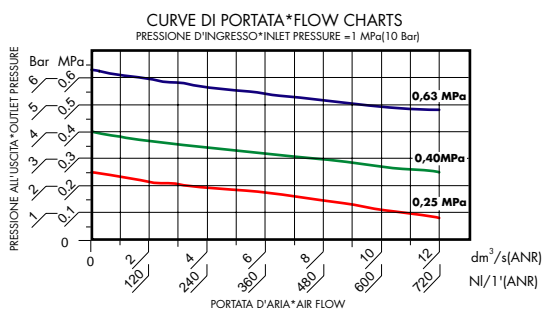
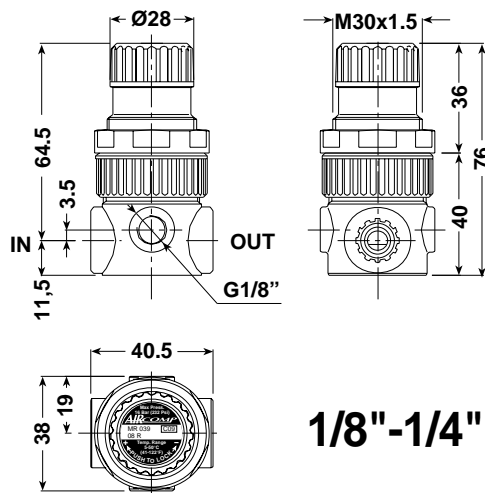

Microregolatore di precisione

Modello sensibile ad alte prestazioni con membrana a rotolamento. Grande stabilità; basse perdite di carico.

- * Rapida eliminazione delle sovrappressioni a valle.
- * Possibilità di fissaggio a pannello con ghiera o a richiesta a parete con staffa.
- * Utilizzabile nelle versioni per aria (con relieving e pomello rosso) e per acqua (senza relieving e pomello nero).
- * Pomello con dispositivo di bloccaggio della regolazione.
- * Campi di pressione:
0÷2 Bar, 0÷4 Bar, 0÷8 Bar (standard), 0÷12,5 Bar
0÷0,2 MPa, 0÷0,4 MPa, 0÷0,8 MPa (standard), 0÷1,25 MPa
- * Pressione massima d'ingresso: 16 Bar (1,60 MPa).
- * Range di temperatura: 5÷50°C (41÷122°F).
- * Coppia di serraggio max. inserti G1/8" IN-OUT: 20 N·m.
- * Coppia di serraggio max. inserti G1/4" IN-OUT: 25 N·m.
- * Portata di riferimento (P=6,3 Bar - Δp=1 Bar): 450 NI/min.
- * Peso: 0,100 Kg.
- * E' disponibile anche in versione:
(FA) A FUGA D'ARIA CONTROLLATA, che consente di ottenere un'altissima precisione della pressione regolata.
(SR) A SCARICO RAPIDO, montato tra valvola e attuatore consente un rapido scarico del circuito, all'azzerarsi della pressione di alimentazione.

Precision Microregulator

Sensitive high performance model with rolling diaphragm; high stability with low load losses and big flow rate.

- * Downstream overpressures quickly eliminated.
- * Can be wall mounted with ring nut for panel assembling or, on request, with bracket.
- * Usable on version for air (with relieving and red knob) or for water (without relieving and black knob).
- * Lockable safety knob.
- * Pressure ranges:
0÷2 Bar, 0÷4 Bar, 0÷8 Bar (standard), 0÷12,5 Bar
0÷0,2 MPa, 0÷0,4 MPa, 0÷0,8 MPa (standard), 0÷1,25 MPa
- * Maximum inlet pressure: 16 Bar (1,60 MPa).
- * Temperature range: 5÷50°C (41÷122°F).
- * Max. torque inserts G1/8" IN-OUT: 20 N·m.
- * Max. torque inserts G1/4" IN-OUT: 25 N·m.
- * Reference flow rate (P=6,3 Bar - Δp=1 Bar): 450 NI/min.
- * Weight: 0,100 Kg.
- * Are available other two versions:
(FA) provided with a CONTROLLED AIR ESCAPE which is able to achieve highly accurate pressure adjustment.
(SR) provided with a FAST BLOWDOWN mounted between valve and actuator; this device allows a rapid discharge when inlet pressure is stopped.

MICROREGOLATORI - Serie 038-039

MICROREGULATORS - 038-039 line

Guida alle referenze Guide to references

MR 1/4" 038 08 R

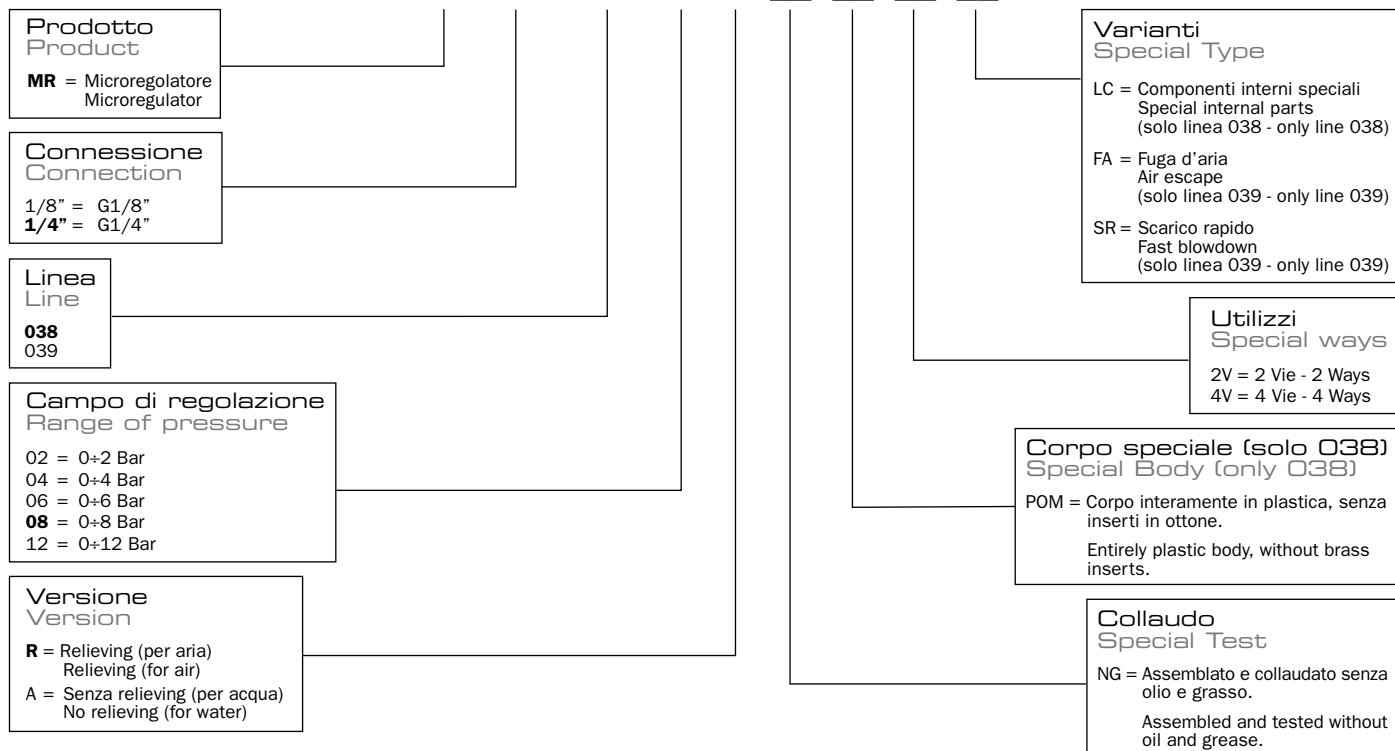

4

Microregolatore "MR 038" Microregulator "MR 038"

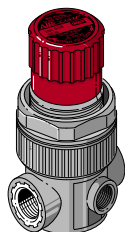

CODICE-CODE	REF.
038.00.00011	MR 1/8" 038 02 R
038.00.00009	MR 1/8" 038 04 R
→ 038.00.00024	MR 1/8" 038 08 R
038.00.00021	MR 1/8" 038 12 R
038.00.00045	MR 1/8" 038 02 A
038.00.00043	MR 1/8" 038 04 A
038.00.00031	MR 1/8" 038 08 A
038.00.00044	MR 1/8" 038 12 A
038.00.00033	MR 1/4" 038 02 R
038.00.00041	MR 1/4" 038 04 R
→ 038.00.00032	MR 1/4" 038 08 R
038.00.00034	MR 1/4" 038 12 R
038.00.00035	MR 1/4" 038 02 A
038.00.00025	MR 1/4" 038 04 A
038.00.00019	MR 1/4" 038 08 A
038.00.00023	MR 1/4" 038 12 A

Microregolatore "MR 039" Microregulator "MR 039"

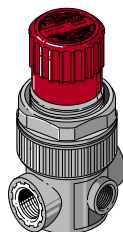

CODICE-CODE	REF.
039.00.00001	MR 1/8" 039 02 R
039.00.00002	MR 1/8" 039 04 R
→ 039.00.00003	MR 1/8" 039 08 R
039.00.00004	MR 1/8" 039 12 R
039.00.00201	MR 1/8" 039 02 A
039.00.00202	MR 1/8" 039 04 A
039.00.00203	MR 1/8" 039 08 A
039.00.00204	MR 1/8" 039 12 A
039.00.00401	MR 1/4" 039 02 R
039.00.00402	MR 1/4" 039 04 R
→ 039.00.00403	MR 1/4" 039 08 R
039.00.00404	MR 1/4" 039 12 R
039.00.00601	MR 1/4" 039 02 A
039.00.00602	MR 1/4" 039 04 A
039.00.00603	MR 1/4" 039 08 A
039.00.00604	MR 1/4" 039 12 A

Microregolatore speciale "LC" Special Microregulator "LC"

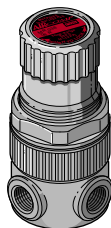

2 Vie
2 Ways

CODICE-CODE	REF.
038.00.00129	MR 1/8" 038 NG 02 A 2V POM LC
038.00.00130	MR 1/8" 038 NG 04 A 2V POM LC
038.00.00092	MR 1/8" 038 NG 08 A 2V POM LC
038.00.00131	MR 1/8" 038 NG 12 A 2V POM LC

4 Vie
4 Ways

CODICE-CODE	REF.
038.00.00126	MR 1/8" 038 NG 02 A 4V POM LC
038.00.00127	MR 1/8" 038 NG 04 A 4V POM LC
038.00.00120	MR 1/8" 038 NG 08 A 4V POM LC
038.00.00128	MR 1/8" 038 NG 12 A 4V POM LC

Microregolatore "MR 039 FA" Microregulator "MR 039 FA"

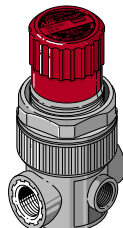

CODICE-CODE	REF.
039.00.00701	MR 1/8" 039 02 R FA
039.00.00702	MR 1/8" 039 04 R FA
→ 039.00.00703	MR 1/8" 039 08 R FA
039.00.00704	MR 1/8" 039 12 R FA
039.00.00801	MR 1/4" 039 02 R FA
039.00.00802	MR 1/4" 039 04 R FA
→ 039.00.00803	MR 1/4" 039 08 R FA
039.00.00804	MR 1/4" 039 12 R FA

→ = Standard version

MICROREGOLATORI - Serie 038-039

MICROREGULATORS - 038-039 line

Microregolatore "non manomettabile"
Microregulator "not adjustable"

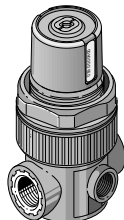

Microregolatore con pressione impostata a richiesta, con pomello bloccato antimanomissione.

Microregulators with pre-set pressure and fixed knob not adjustable.

Guida alle referenze
Guide to references

Microregolatore "MR 039 SR"
Microregulator "MR 039 SR"

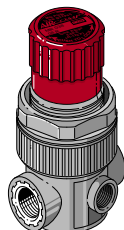

	CODICE-CODE	REF.
	039.00.00022	MR 1/8" 039 02 R SR
	039.00.00023	MR 1/8" 039 04 R SR
→	039.00.00024	MR 1/8" 039 08 R SR
	039.00.00025	MR 1/8" 039 12 R SR
	039.00.00441	MR 1/4" 039 02 R SR
	039.00.00442	MR 1/4" 039 04 R SR
→	039.00.00443	MR 1/4" 039 08 R SR
	039.00.00444	MR 1/4" 039 12 R SR

→ = Standard version

Accessori e ricambi Spare parts

Gruppo membrana completo
Diaphragm complete

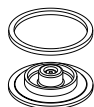

CODICE-CODE	LINE	VERSION
C38.00.00073	038	RELIEVING
C38.00.00074	038	NON RELIEVING
C38.00.00087	038 LC	NON RELIEVING
C39.00.00009	039	RELIEVING
C39.00.00010	039	NON RELIEVING

Molla regolazione
Regulation spring



CODICE-CODE	LINE	SET REGULATION
A38.00.00039	038-039	0÷2 Bar
A38.00.00040	038-039	0÷4 Bar
A38.00.00020	038-039	0÷8 Bar
A38.00.00021	038-039	0÷12 Bar

Manometro
Gauge

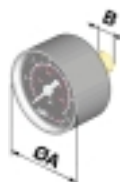

CODICE-CODE	Scala / Range	A	B
TAM91447111	0 - 2,5 bar	40	G1/8"
TAM91447311	0 - 6 bar	40	G1/8"
TAM91447421	0 - 12 bar	40	G1/8"
TAM44512001	0 - 1,2 MPa	40	G1/8"

Staffa fissaggio a parete
Bracket

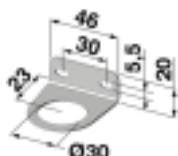

CODICE-CODE
C38.00.00069

Grano G1/8"
Plug G1/8"



CODICE-CODE	LINE
B38.00.00018	038 - 039